

FEATURES

- Fully specified rail to rail at $V_{CC} = 2.5\text{ V to }5.5\text{ V}$**
- Input common-mode voltage from $-0.2\text{ V to }V_{CC} + 0.2\text{ V}$**
- Low glitch CMOS-/TTL-compatible output stage**
- Complementary outputs**
- 3.5 ns propagation delay**
- 12 mW at 3.3 V**
- Shutdown pin**
- Single-pin control for programmable hysteresis and latch**
- Power supply rejection > 50 dB**
- $-40^{\circ}\text{C to }+125^{\circ}\text{C}$ operation**

APPLICATIONS

- High speed instrumentation**
- Clock and data signal restoration**
- Logic level shifting or translation**
- Pulse spectroscopy**
- High speed line receivers**
- Threshold detection**
- Peak and zero-crossing detectors**
- High speed trigger circuitry**
- Pulse-width modulators**
- Current-/voltage-controlled oscillators**
- Automatic test equipment (ATE)**

GENERAL DESCRIPTION

The ADCMP603 is a very fast comparator fabricated on XFCB2, an Analog Devices, Inc. proprietary process. This comparator is exceptionally versatile and easy to use. Features include an input range from $V_{EE} - 0.5\text{ V to }V_{CC} + 0.2\text{ V}$, low noise complementary TTL-/CMOS-compatible output drivers, latch inputs with adjustable hysteresis and a shutdown input.

The device offers 3.5 ns propagation delay with 10 mV overdrive on 4 mA typical supply current.

A flexible power supply scheme allows the device to operate with a single +2.5 V positive supply and a $-0.5\text{ V to }+2.8\text{ V}$ input signal range up to a +5.5 V positive supply with a $-0.5\text{ V to }+5.8\text{ V}$ input signal range. Split input/output supplies with no sequencing restrictions support a wide input signal range while still allowing independent output swing control and power savings.

FUNCTIONAL BLOCK DIAGRAM

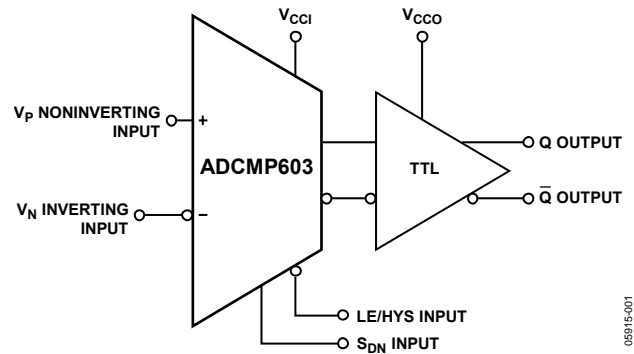

Figure 1.

05915-001

The device passes 4.5 kV HBM ESD testing and the absolute maximum ratings include current limits for all pins.

The complementary TTL-/CMOS-compatible output stage is designed to drive up to 5 pF with full timing specs and to degrade in a graceful and linear fashion as additional capacitance is added. The comparator input stage offers robust protection against large input overdrive, and the outputs do not phase reverse when the valid input signal range is exceeded. Latch and programmable hysteresis features are also provided with a unique single-pin control option.

The ADCMP603 is available in a 12-lead LFCSP package.

Rev. 0

Information furnished by Analog Devices is believed to be accurate and reliable. However, no responsibility is assumed by Analog Devices for its use, nor for any infringements of patents or other rights of third parties that may result from its use. Specifications subject to change without notice. No license is granted by implication or otherwise under any patent or patent rights of Analog Devices. Trademarks and registered trademarks are the property of their respective owners.

TABLE OF CONTENTS

Features	1	Application Information.....	10
Applications.....	1	Power/Ground Layout and Bypassing.....	10
Functional Block Diagram	1	TTL-/CMOS-Compatible Output Stage	10
General Description	1	Using/Disabling the Latch Feature.....	10
Revision History	2	Optimizing Performance.....	11
Specifications.....	3	Comparator Propagation Delay Dispersion	11
Electrical Characteristics	3	Comparator Hysteresis	11
Timing Information	5	Crossover Bias Point	12
Absolute Maximum Ratings.....	6	Minimum Input Slew Rate Requirement	12
Thermal Resistance	6	Typical Application Circuits	13
ESD Caution.....	6	Outline Dimensions	14
Pin Configuration and Function Descriptions.....	7	Ordering Guide	14
Typical Performance Characteristics	8		

REVISION HISTORY

10/06—Revision 0: Initial Version

SPECIFICATIONS

ELECTRICAL CHARACTERISTICS

$V_{CCI} = V_{CCO} = 2.5\text{ V}$, $T_A = 25^\circ\text{C}$, unless otherwise noted.

Table 1.

Parameter	Symbol	Conditions	Min	Typ	Max	Unit
DC INPUT CHARACTERISTICS						
Voltage Range	V_P, V_N	$V_{CC} = 2.5\text{ V to }5.5\text{ V}$	-0.5		$V_{CC} + 0.2$	V
Common-Mode Range		$V_{CC} = 2.5\text{ V to }5.5\text{ V}$	-0.2		$V_{CC} + 0.2$	V
Differential Voltage		$V_{CC} = 2.5\text{ V to }5.5\text{ V}$		$V_{CC} + 0.8$		V
Offset Voltage	V_{OS}		-5.0	± 2	+5.0	mV
Bias Current	I_P, I_N		-5.0	± 2	+5.0	μA
Offset Current			-2.0		2.0	μA
Capacitance	C_P, C_N			1.0		pF
Resistance, Differential Mode		-0.5 V to $V_{CC} + 0.2\text{ V}$	200	700		k Ω
Resistance, Common Mode		-0.2 V to $V_{CC} + 0.2\text{ V}$	100	350		k Ω
Active Gain	A_V			85		dB
Common-Mode Rejection Ratio	CMRR	$V_{CCI} = 2.5\text{ V}, V_{CCO} = 2.5\text{ V}, V_{CM} = -0.2\text{ V to }+2.7\text{ V}$	50			dB
		$V_{CCI} = 5.5\text{ V}, V_{CCO} = 5.5\text{ V}, V_{CM} = -0.2\text{ V to }+5.7\text{ V}$	50			dB
Hysteresis		$R_{HYS} = \infty$		0.1		mV
LATCH ENABLE PIN CHARACTERISTICS						
V_{IH}		Hysteresis is shut off	2.0		V_{CC}	V
V_{IL}		Latch mode guaranteed	-0.2	+0.4	+0.8	V
I_{IH}		$V_{IH} = V_{CC}$	-6		+6	μA
I_{OL}		$V_{IL} = 0.4\text{ V}$			-0.1	mA
HYSTERESIS MODE AND TIMING						
Hysteresis Mode Bias Voltage		Current sink -1 μA	1.145	1.25	1.35	V
Resistor Value		Hysteresis = 120 mV	65	80	95	k Ω
Hysteresis Current		Hysteresis = 120 mV	-18	-14	-10	μA
Latch Setup Time	t_S	$V_{OD} = 50\text{ mV}$		-2.0		ns
Latch Hold Time	t_H	$V_{OD} = 50\text{ mV}$		2.0		ns
Latch-to-Output Delay	t_{PLOH}, t_{PLOL}	$V_{OD} = 50\text{ mV}$		30		ns
Latch Minimum Pulse Width	t_{PL}	$V_{OD} = 50\text{ mV}$		23		ns
SHUTDOWN PIN CHARACTERISTICS						
V_{IH}		Comparator is operating	2.0		V_{CCO}	V
V_{IL}		Shutdown guaranteed	-0.2	+0.4	+0.6	V
I_{IH}		$V_{IH} = V_{CC}$	-6		+6	μA
I_{OL}		$V_{IL} = 0\text{ V}$		-80		μA
Sleep Time	t_{SD}	$I_{OUT} < 0.5\text{ mA}$		20		ns
Wake-Up Time	t_H	$V_{OD} = 100\text{ mV}$, output valid		50		ns
DC OUTPUT CHARACTERISTICS						
Output Voltage High Level	V_{OH}	$V_{CCO} = 2.5\text{ V to }5.5\text{ V}$ $I_{OH} = 8\text{ mA}, V_{CCO} = 2.5\text{ V}$	$V_{CC} - 0.4$			V
Output Voltage High Level -40°C	V_{OH}	$I_{OH} = 6\text{ mA}, V_{CCO} = 2.5\text{ V}$	$V_{CC} - 0.4$			V
Output Voltage Low Level	V_{OL}	$I_{OL} = 8\text{ mA}, V_{CCO} = 2.5\text{ V}$			0.4	V
Output Voltage Low Level -40°C	V_{OL}	$I_{OL} = 6\text{ mA}, V_{CCO} = 2.5\text{ V}$			0.4	V

ADCMP603

Parameter	Symbol	Conditions	Min	Typ	Max	Unit
AC PERFORMANCE¹						
Rise Time /Fall time	t_R/t_F	10% to 90%, $V_{CCO} = 2.5\text{ V}$		2.2		ns
		10% to 90%, $V_{CCO} = 5.5\text{ V}$		4.5		ns
Propagation Delay	t_{PD}	$V_{OD} = 50\text{ mV}$, $V_{CCO} = 2.5\text{ V}$		3.5		ns
		$V_{OD} = 50\text{ mV}$, $V_{CCO} = 5.5\text{ V}$		4.8		ns
		$V_{OD} = 10\text{ mV}$, $V_{CCO} = 2.5\text{ V}$		5		ns
		$V_{OD} = 10\text{ mV}$, $V_{CCO} = 5.5\text{ V}$				
Propagation Delay Skew—Rising to Falling Transition	$t_{PINSKEW}$	$V_{CCO} = 2.5\text{ V to } 5.5\text{ V}$ $V_{OD} = 50\text{ mV}$		500		ps
Propagation Delay Skew—Q to QB	$t_{DIFFSKEW}$	$V_{CCO} = 2.5\text{ V to } 5.5\text{ V}$ $V_{OD} = 50\text{ mV}$		300		ps
Overdrive Dispersion		$10\text{ mV} < V_{OD} < 125\text{ mV}$		1.5		ns
Common-Mode Dispersion		$-2\text{ V} < V_{CM} < V_{CCI} + 2\text{ V}$ $V_{OD} = 50\text{ mV}$		200		ps
Minimum Pulse Width	PW_{MIN}	$V_{CCI} = V_{CCO} = 2.5\text{ V}$ $PW_{OUT} = 90\% \text{ of } PW_{IN}$		3.3		ns
		$V_{CCI} = V_{CCO} = 5.5\text{ V}$ $PW_{OUT} = 90\% \text{ of } PW_{IN}$		5.5		ns
POWER SUPPLY						
Input Supply Voltage Range	V_{CCI}		2.5		5.5	V
Output Supply Voltage Range	V_{CCO}		2.5		5.5	V
Positive Supply Differential	$V_{CCI} - V_{CCO}$	Operating	-3.0		+3.0	V
Positive Supply Differential	$V_{CCI} - V_{CCO}$	Nonoperating	-5.5		+5.5	V
Input Section Supply Current	I_{VCCI}	$V_{CCI} = 2.5\text{ V to } 5.5\text{ V}$		1.1	1.8	mA
Output Section Supply Current	I_{VCCO}	$V_{CCI} = 2.5\text{ V to } 5.5\text{ V}$		2.3	3.5	mA
Power Dissipation	P_D	$V_{CC} = 2.5\text{ V}$		9	11	mW
		$V_{CC} = 5.5\text{ V}$		21	30	mW
Power Supply Rejection Ratio	PSRR	$V_{CCI} = 2.5\text{ V to } 5.5\text{ V}$	-50			dB
Shutdown Mode Supply Current		$V_{CC} = 2.5\text{ V}$		290	430	μA

¹ $V_{IN} = 100\text{ mV}$ square input at 50 MHz, $V_{CM} = 0\text{ V}$, $C_L = 5\text{ pF}$, $V_{CCI} = V_{CCO} = 2.5\text{ V}$, unless otherwise noted.

TIMING INFORMATION

Figure 2 illustrates the ADCMP603 latch timing relationships. Table 2 provides definitions of the terms shown in Figure 2.

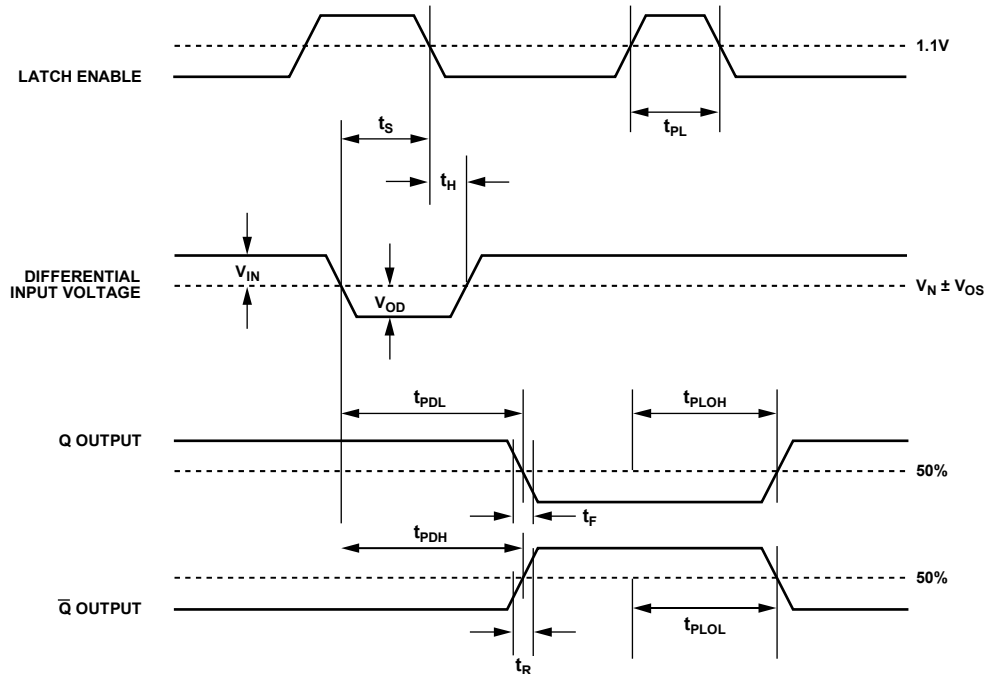

Figure 2. System Timing Diagram

06915-023

Table 2. Timing Descriptions

Symbol	Timing	Description
t_{PDH}	Input to output high delay	Propagation delay measured from the time the input signal crosses the reference (\pm the input offset voltage) to the 50% point of an output low-to-high transition.
t_{PDL}	Input to output low delay	Propagation delay measured from the time the input signal crosses the reference (\pm the input offset voltage) to the 50% point of an output high-to-low transition.
t_{PLOH}	Latch enable to output high delay	Propagation delay measured from the 50% point of the latch enable signal low-to-high transition to the 50% point of an output low-to-high transition.
t_{PLOL}	Latch enable to output low delay	Propagation delay measured from the 50% point of the latch enable signal low-to-high transition to the 50% point of an output high-to-low transition.
t_H	Minimum hold time	Minimum time after the negative transition of the latch enable signal that the input signal must remain unchanged to be acquired and held at the outputs.
t_{PL}	Minimum latch enable pulse width	Minimum time that the latch enable signal must be high to acquire an input signal change.
t_S	Minimum setup time	Minimum time before the negative transition of the latch enable signal occurs that an input signal change must be present to be acquired and held at the outputs.
t_R	Output rise time	Amount of time required to transition from a low to a high output as measured at the 20% and 80% points.
t_F	Output fall time	Amount of time required to transition from a high to a low output as measured at the 20% and 80% points.
V_{OD}	Voltage overdrive	Difference between the input voltages V_A and V_B .

ABSOLUTE MAXIMUM RATINGS

Table 3.

Parameter	Rating
Supply Voltages	
Input Supply Voltage (V_{CC1} to GND)	-0.5 V to +6.0 V
Output Supply Voltage (V_{CC0} to GND)	-0.5 V to +6.0 V
Positive Supply Differential ($V_{CC1} - V_{CC0}$)	-6.0 V to +6.0 V
Input Voltages	
Input Voltage	-0.5 V to $V_{CC1} + 0.5$ V
Differential Input Voltage	$\pm(V_{CC1} + 0.5$ V)
Maximum Input/Output Current	± 50 mA
Shutdown Control Pin	
Applied Voltage (HYS to GND)	-0.5 V to $V_{CC0} + 0.5$ V
Maximum Input/Output Current	± 50 mA
Latch/Hysteresis Control Pin	
Applied Voltage (HYS to GND)	-0.5 V to $V_{CC0} + 0.5$ V
Maximum Input/Output Current	± 50 mA
Output Current	
Output Current	± 50 mA
Temperature	
Operating Temperature, Ambient	-40°C to +125°C
Operating Temperature, Junction	150°C
Storage Temperature Range	-65°C to +150°C

Stresses above those listed under Absolute Maximum Ratings may cause permanent damage to the device. This is a stress rating only; functional operation of the device at these or any other conditions above those indicated in the operational section of this specification is not implied. Exposure to absolute maximum rating conditions for extended periods may affect device reliability.

THERMAL RESISTANCE

θ_{JA} is specified for the worst-case conditions, that is, a device soldered in a circuit board for surface-mount packages.

Table 4. Thermal Resistance

Package Type	θ_{JA} ¹	Unit
ADCMP603 LFCSP 12-lead	62	°C/W

¹ Measurement in still air.

ESD CAUTION

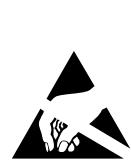

ESD (electrostatic discharge) sensitive device. Charged devices and circuit boards can discharge without detection. Although this product features patented or proprietary protection circuitry, damage may occur on devices subjected to high energy ESD. Therefore, proper ESD precautions should be taken to avoid performance degradation or loss of functionality.

PIN CONFIGURATION AND FUNCTION DESCRIPTIONS

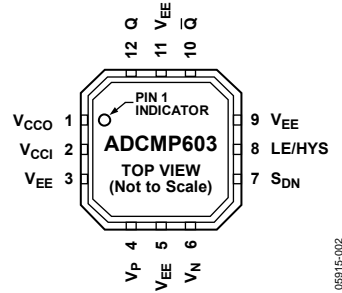

Figure 3. ADCMP603 Pin Configuration

Table 5. Pin Function Descriptions

Pin No.	Mnemonic	Description
1	V _{CCO}	Output Section Supply.
2	V _{CCI}	Input Section Supply.
3	V _{EE}	Negative Supply Voltage.
4	V _P	Noninverting Analog Input.
5	V _{EE}	Negative Supply Voltage.
6	V _N	Inverting Analog Input.
7	S _{DN}	Shutdown. Drive this pin low to shut down the device.
8	LE/HYS	Latch/Hysteresis Control. Bias with resistor or current for hysteresis adjustment; drive low to latch.
9	V _{EE}	Negative Supply Voltage.
10	\overline{Q}	Inverting Output. \overline{Q} is at logic low if the analog voltage at the noninverting input, V _P , is greater than the analog voltage at the inverting input, V _N , if the comparator is in compare mode. See the LE/HYS pin description (Pin 8) for more information.
11	V _{EE}	Negative Supply Voltage.
12	Q	Noninverting Output. Q is at logic high if the analog voltage at the noninverting input, V _P , is greater than the analog voltage at the inverting input, V _N , if the comparator is in compare mode. See the LE pin description (Pin 8) for more information.
Heat Sink Paddle	V _{EE}	The metallic back surface of the package is electrically connected to V _{EE} . It can be left floating because Pin 3, Pin 5, Pin 9, and Pin 11 provide adequate electrical connection. It can also be soldered to the application board if improved thermal and/or mechanical stability is desired. Exposed metal at package corners is connected to the heat sink paddle.

ADCMP603

TYPICAL PERFORMANCE CHARACTERISTICS

$V_{CCI} = V_{CCO} = 2.5\text{ V}$, $T_A = 25^\circ\text{C}$, unless otherwise noted.

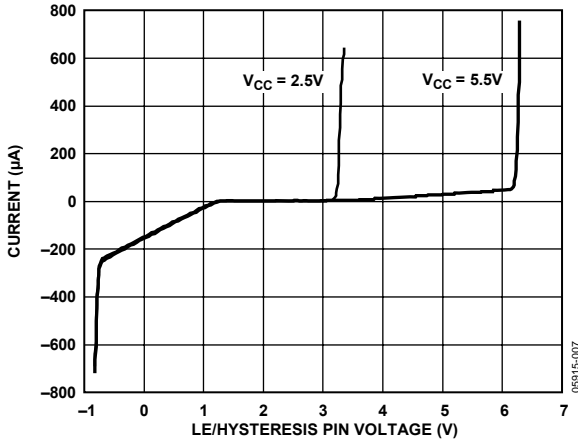

Figure 4. LE/HYS Pin I/V Curve

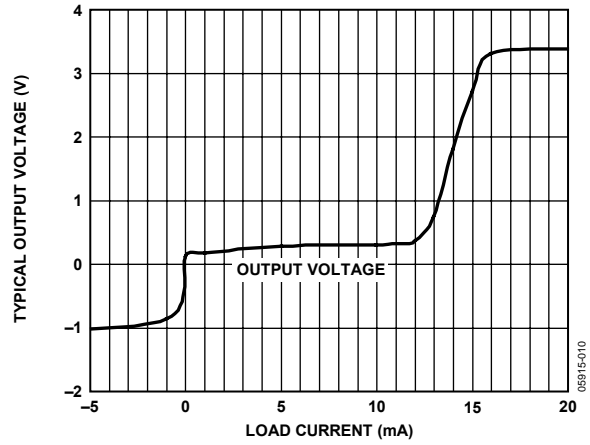

Figure 7. V_{OL} vs. Load Current

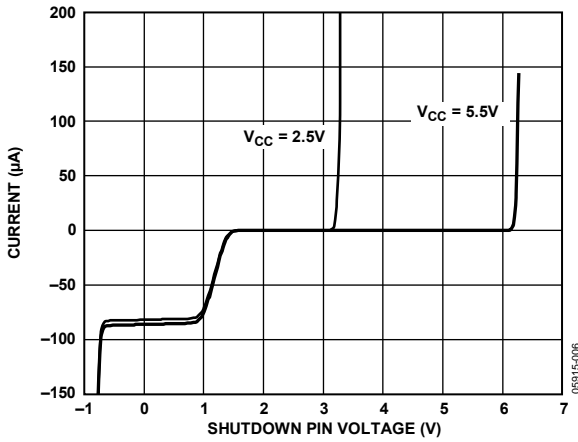

Figure 5. S_{DN} Pin I/V Curve

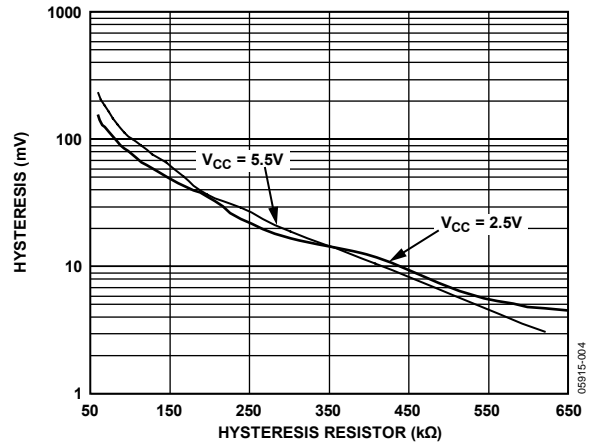

Figure 8. Hysteresis vs. R_{HYS}

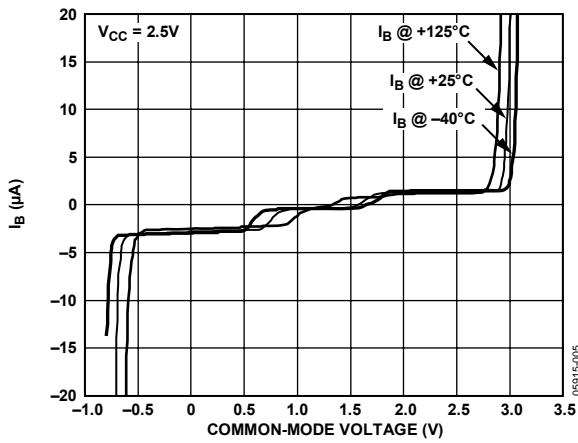

Figure 6. Input Bias Current vs. Input Common Mode

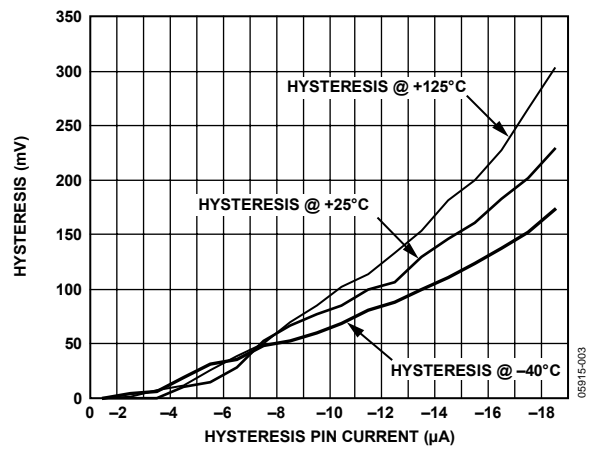

Figure 9. Hysteresis vs. Hysteresis Pin Current

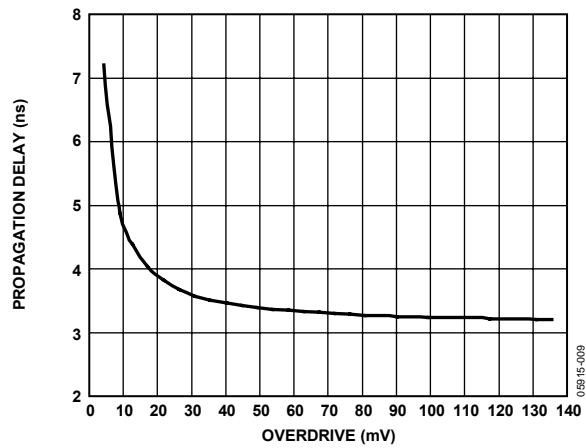

Figure 10. Propagation Delay vs. Input Overdrive

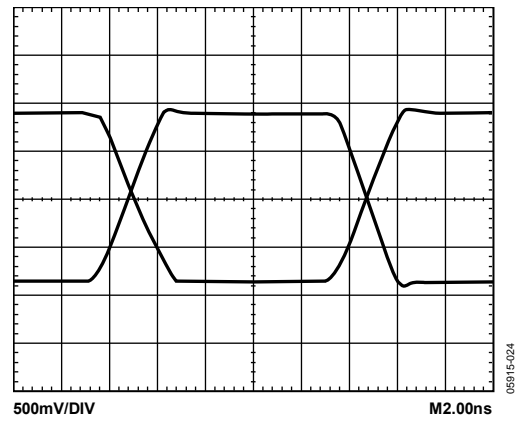

Figure 12. 50 MHz Output Voltage Waveform at $V_{CCO} = 2.5 V$

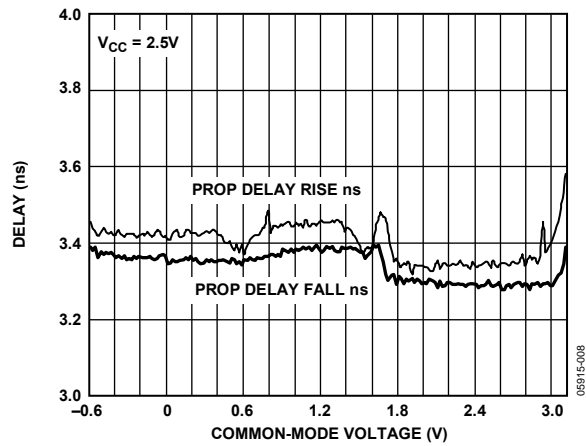

Figure 11. Propagation Delay vs. Input Common Mode

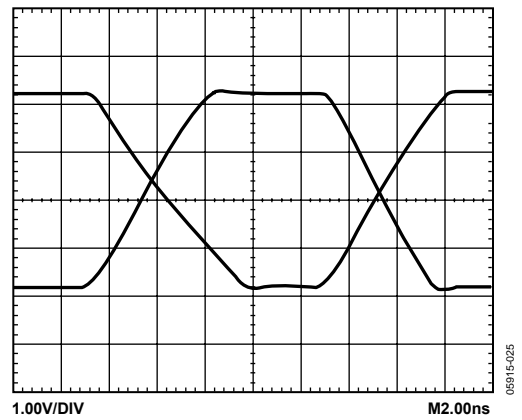

Figure 13. 50 MHz Output Voltage Waveform at $V_{CCO} = 5.5 V$

APPLICATION INFORMATION

POWER/GROUND LAYOUT AND BYPASSING

The ADCMP603 comparator is a very high speed device. Despite the low noise output stage, it is essential to use proper high speed design techniques to achieve the specified performance. Because comparators are uncompensated amplifiers, feedback in any phase relationship is likely to cause oscillations or undesired hysteresis. Of critical importance is the use of low impedance supply planes, particularly the output supply plane (V_{CCO}) and the ground plane (GND). Individual supply planes are recommended as part of a multilayer board. Providing the lowest inductance return path for switching currents ensures the best possible performance in the target application.

It is also important to adequately bypass the input and output supplies. Multiple high quality 0.01 μF bypass capacitors should be placed as close as possible to each of the V_{CCI} and V_{CCO} supply pins and should be connected to the GND plane with redundant vias. At least one of these should be placed to provide a physically short return path for output currents flowing back from ground to the V_{CCO} pin. High frequency bypass capacitors should be carefully selected for minimum inductance and ESR. Parasitic layout inductance should also be strictly controlled to maximize the effectiveness of the bypass at high frequencies.

If the input and output supplies have been connected separately such that $V_{CCI} \neq V_{CCO}$, care should be taken to bypass each of these supplies separately to the GND plane. A bypass between them is futile and defeats the purpose of having separate pins. It is recommended that the GND plane separate the V_{CCI} and V_{CCO} planes when the circuit board layout is designed to minimize coupling between the two supplies and to take advantage of the additional bypass capacitance from each respective supply to the ground plane. This enhances the performance when split input/output supplies are used. If the input and output supplies are connected together for single-supply operation such that $V_{CCI} = V_{CCO}$, coupling between the two supplies is unavoidable; however, careful board placement can help keep output return currents away from the inputs.

TTL-/CMOS-COMPATIBLE OUTPUT STAGE

Specified propagation delay performance can be achieved only by keeping the capacitive load at or below the specified minimums. The low skew complementary outputs of the ADCMP603 are designed to directly drive one Schottky TTL or three low power Schottky TTL loads or the equivalent. For large fan outputs, buses, or transmission lines, use an appropriate buffer to maintain the excellent speed and stability of the comparator.

With the rated 5 pF load capacitance applied, more than half of the total device propagation delay is output stage slew time, even at 2.5 V V_{CC} . Because of this, the total prop delay decreases as V_{CCO} decreases, and instability in the power supply may appear as excess delay dispersion.

This delay is measured to the 50% point for the supply in use; therefore, the fastest times are observed with the V_{CC} supply at 2.5 V, and larger values are observed when driving loads that switch at other levels.

When duty cycle accuracy is critical, the logic being driven should switch at 50% of V_{CC} and load capacitance should be minimized. When in doubt, it is best to power V_{CCO} or the entire device from the logic supply and rely on the input PSRR and CMRR to reject noise.

Overdrive and input slew rate dispersions are not significantly affected by output loading and V_{CC} variations.

The TTL-/CMOS-compatible output stage is shown in the simplified schematic diagram (Figure 14). Because of its inherent symmetry and generally good behavior, this output stage is readily adaptable for driving various filters and other unusual loads.

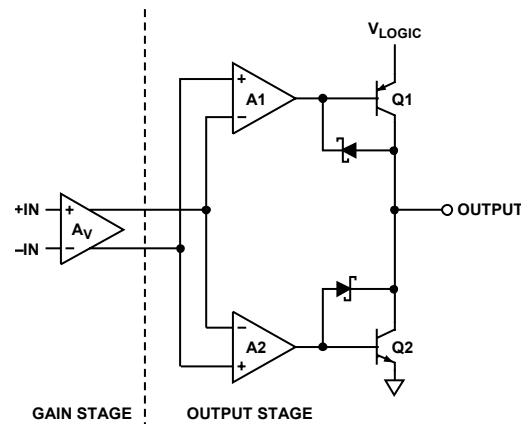

Figure 14. Simplified Schematic Diagram of TTL-/CMOS-Compatible Output Stage

06915-012

USING/DISABLING THE LATCH FEATURE

The latch input is designed for maximum versatility. It can safely be left floating for fixed hysteresis or be tied to V_{CC} to remove the hysteresis, or it can be driven low by any standard TTL/CMOS device as a high speed latch.

In addition, the pin can be operated as a hysteresis control pin with a bias voltage of 1.25 V nominal and an input resistance of approximately 7000 Ω , allowing the comparator hysteresis to be easily controlled by either a resistor or an inexpensive CMOS DAC.

Hysteresis control and latch mode can be used together if an open drain, an open collector, or a three-state driver is connected parallel to the hysteresis control resistor or current source.

Due to the programmable hysteresis feature, the logic threshold of the latch pin is approximately 1.1 V regardless of V_{CC} .

OPTIMIZING PERFORMANCE

As with any high speed comparator, proper design and layout techniques are essential for obtaining the specified performance. Stray capacitance, inductance, inductive power and ground impedances, or other layout issues can severely limit performance and often cause oscillation. Large discontinuities along input and output transmission lines can also limit the specified pulse-width dispersion performance. The source impedance should be minimized as much as is practicable. High source impedance, in combination with the parasitic input capacitance of the comparator, causes an undesirable degradation in bandwidth at the input, thus degrading the overall response. Thermal noise from large resistances can easily cause extra jitter with slowly slewing input signals; higher impedances encourage undesired coupling.

COMPARATOR PROPAGATION DELAY DISPERSION

The ADCMP603 comparator is designed to reduce propagation delay dispersion over a wide input overdrive range of 5 mV to $V_{CCI} - 1$ V. Propagation delay dispersion is the variation in propagation delay that results from a change in the degree of overdrive or slew rate (that is, how far or how fast the input signal exceeds the switching threshold).

Propagation delay dispersion is a specification that becomes important in high speed, time-critical applications, such as data communication, automatic test and measurement, and instrumentation. It is also important in event-driven applications, such as pulse spectroscopy, nuclear instrumentation, and medical imaging. Dispersion is defined as the variation in propagation delay as the input overdrive conditions are changed (Figure 15 and Figure 16).

ADCMP603 dispersion is typically < 2 ns as the overdrive varies from 10 mV to 125 mV. This specification applies to both positive and negative signals because the device has very closely matched delays for both positive-going and negative-going inputs.

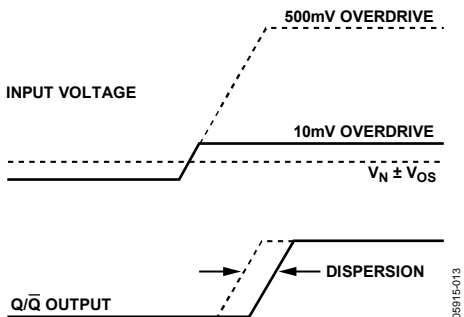

Figure 15. Propagation Delay—Overdrive Dispersion

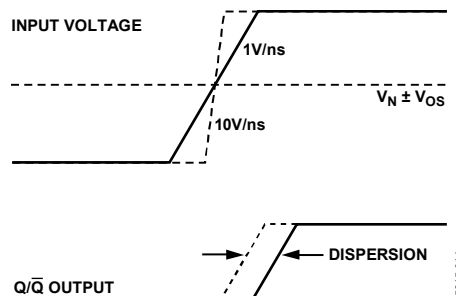

Figure 16. Propagation Delay—Slew Rate Dispersion

COMPARATOR HYSTERESIS

The addition of hysteresis to a comparator is often desirable in a noisy environment, or when the differential input amplitudes are relatively small or slow moving. Figure 17 shows the transfer function for a comparator with hysteresis. As the input voltage approaches the threshold (0.0 V, in this example) from below the threshold region in a positive direction, the comparator switches from low to high when the input crosses $+V_H/2$, and the new switching threshold becomes $-V_H/2$. The comparator remains in the high state until the new threshold, $-V_H/2$, is crossed from below the threshold region in a negative direction. In this manner, noise or feedback output signals centered on 0.0 V input cannot cause the comparator to switch states unless it exceeds the region bounded by $\pm V_H/2$.

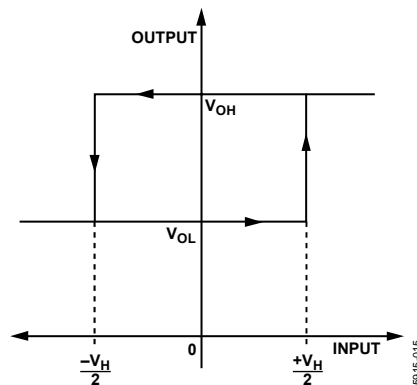

Figure 17. Comparator Hysteresis Transfer Function

The customary technique for introducing hysteresis into a comparator uses positive feedback from the output back to the input. One limitation of this approach is that the amount of hysteresis varies with the output logic levels, resulting in hysteresis that is not symmetric about the threshold. The external feedback network can also introduce significant parasitics that reduce high speed performance and induce oscillation in some cases.

ADCMP603

The ADCMP603 comparator offers a programmable hysteresis feature that can significantly improve accuracy and stability. Connecting an external pull-down resistor or a current source from the LE/HYS pin to GND varies the amount of hysteresis in a predictable, stable manner. Leaving the LE/HYS pin disconnected or driving it high removes the hysteresis. The maximum hysteresis that can be applied using this pin is approximately 160 mV. Figure 18 illustrates the amount of hysteresis applied as a function of the external resistor value, and Figure 9 illustrates hysteresis as a function of the current.

The hysteresis control pin appears as a 1.25 V bias voltage seen through a series resistance of $7\text{ k}\Omega \pm 20\%$ throughout the hysteresis control range. The advantages of applying hysteresis in this manner are improved accuracy, improved stability, reduced component count, and maximum versatility. An external bypass capacitor is not recommended on the HYS pin because it impairs the latch function and often degrades the jitter performance of the device. As described in the Using/Disabling the Latch Feature section, hysteresis control need not compromise the latch function.

CROSSOVER BIAS POINT

In both op amps and comparators, rail-to-rail inputs of this type have a dual front-end design. Certain devices are active near the V_{CC} rail and others are active near the V_{EE} rail. At some predetermined point in the common-mode range, a crossover occurs. At this point, typically $V_{CC}/2$, the direction of the bias current reverses and the measured offset voltages and currents change.

The ADCMP603 slightly elaborates on this scheme. Crossover points can be found at approximately 0.8 V and 1.6 V.

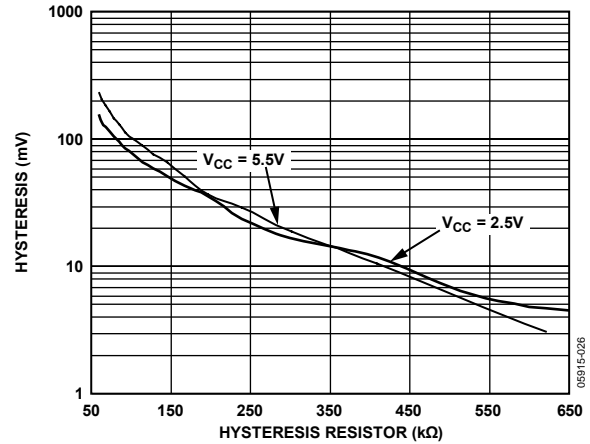

Figure 18. Hysteresis vs. R_{HYS} Control Resistor

MINIMUM INPUT SLEW RATE REQUIREMENT

With the rated load capacitance and normal good PC Board design practice, as discussed in the Optimizing Performance section, these comparators should be stable at any input slew rate with no hysteresis. Broadband noise from the input stage is observed in place of the violent chattering seen with most other high speed comparators. With additional capacitive loading or poor bypassing, more persistent oscillations are seen. This oscillation is due to the high gain bandwidth of the comparator in combination with feedback parasitics in the package and PC board. In many applications, chattering is not harmful since the first cycle of the oscillation occurs close to V_{OS} .

TYPICAL APPLICATION CIRCUITS

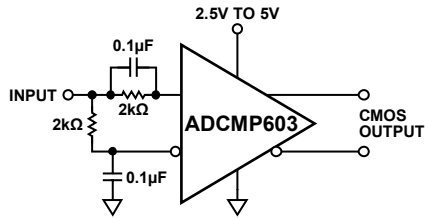

Figure 19. Self-Biased, 50% Slicer

05915-017

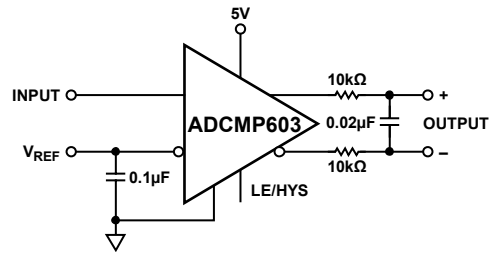

Figure 22. Duty Cycle to Differential Voltage Converter

05915-020

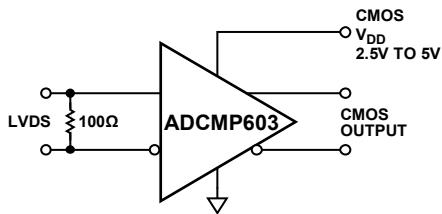

Figure 20. LVDS-to-CMOS Receiver

05915-018

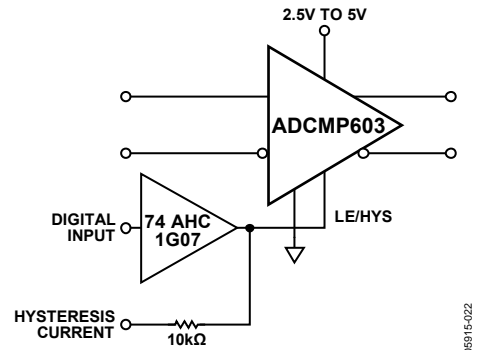

Figure 23. Hysteresis Adjustment with Latch

05915-022

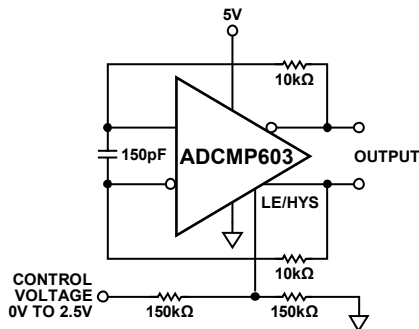

Figure 21. Voltage-Controlled Oscillator

05915-019

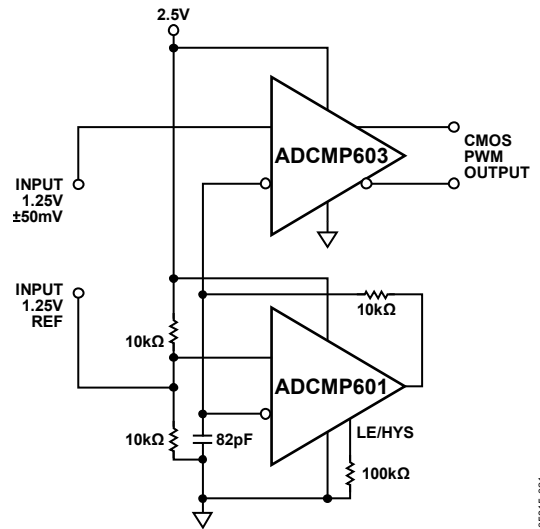
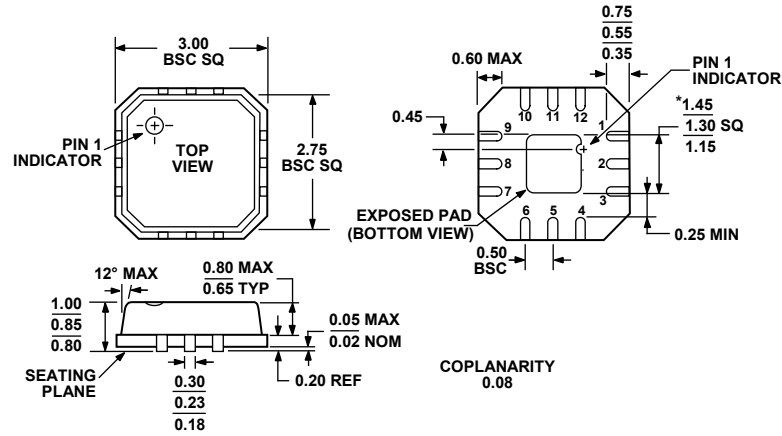

Figure 24. Oscillator and Pulse-Width Modulator

05915-021

ADCMP603

OUTLINE DIMENSIONS



*COMPLIANT TO JEDEC STANDARDS MO-220-VEED-1
EXCEPT FOR EXPOSED PAD DIMENSION.

Figure 25. 12-Lead Lead Frame Chip Scale Package [LFCSP_VQ]
3 mm × 3 mm Body, Very Thin Quad
(CP-12-1)
Dimensions shown in millimeters

ORDERING GUIDE

Model	Temperature Range	Package Description	Package Option	Branding
ADCMP603BCPZ-WP ¹	-40°C to +125°C	12-Lead Lead Frame Chip Scale Package [LFCSP_VQ]	CP-12-1	G0D
ADCMP603BCPZ-R2 ¹	-40°C to +125°C	12-Lead Lead Frame Chip Scale Package [LFCSP_VQ]	CP-12-1	G0D
ADCMP603BCPZ-R7 ¹	-40°C to +125°C	12-Lead Lead Frame Chip Scale Package [LFCSP_VQ]	CP-12-1	G0D

¹Z = Pb-free part.

NOTES

NOTES